

*pHix<sup>®</sup> Compact*  
pH, redox and temperature transmitter



4.1

General



With the advanced and unique design of the *pHix® Compact*, pH can now be measured much easier than before, and nearly all drawbacks of conventional measuring systems are eliminated.

The compact design, with union in one end and male thread in the other end, makes *pHix® Compact* very simple to mount in pipelines and open tanks.

Another innovation is the simple 2-wire 4-20 mA connection with communication capabilities for setup, electrode diagnosis, trouble shooting and calibration.

Also, a new double-junction electrode has been developed for the *pHix® Compact* with lower impedance, increased electrolyte volume, increased junction area and longer lifetime than traditional pH electrodes. The new electrodes can be used successfully in wastewater, potable water and water with low ion concentration.

Features

- Available with 4-20 mA output for pH / redox or with 2 galvanically separated 4-20 mA outputs for both pH and temperature.
- *pHix® Compact* is completely waterproof, and withstands a static pressure of 5 bar.
- No need for fittings or cables - both electrode connections, transmitter and cable comes as one complete unit.
- Built-in temperature sensor.
- *pHix® Compact* is made from chemical resistant Ryton® (PPS) and 316 SS.
- *pHix® Compact* can be loop powered directly from an active 4-20 mA input on e.g. a PLC or indicator.
- Automatic electrode monitoring.
- HART® communication with commands for all configuration parameters.

Buffer adjustment

Buffer adjustment is activated by either turning the transmitter 180 ° or by the switch ring that activates a magnetic relay inside the transmitter.

Buffer adjustment can also be activated from a PLC or through HART® commands via the 4-20 mA channel.

*Buffer adjustment with switch ring:*



1: Rinse the electrode.



2: The switch ring is set to the pH value of the buffer liquid (4, 7, or 10).

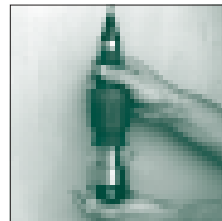

3: *pHix® Compact* is immersed into the buffer liquid. Zero and span is set automatically.

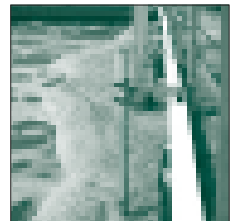

4: *pHix® Compact* can be put into service.

*Buffer adjustment with tilt switch:*

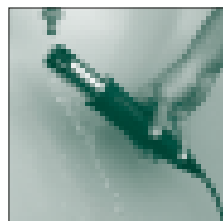

1: Rinse the electrode

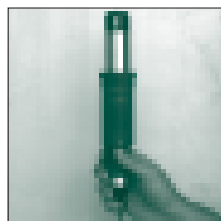

2: *pHix® Compact* is turned upside down.



3: *pHix® Compact* is immersed into the buffer liquid. Zero and span is set automatically.

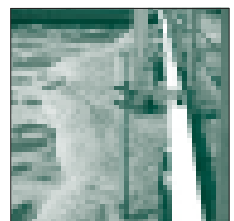

4: *pHix® Compact* can be put into service.

Specifications

*pHix<sup>®</sup> Compact*

Supply:	2-wire supply, 12 - 30 V DC
Temperature range:	- 20 ... + 80 °C
Material:	Ryton <sup>®</sup> (PPS) and 316 SS
Enclosure:	IP 68
Input, pH and mV:	0 -14 pH / - 1000 ... + 1000 mV
Input impedance, pH:	> 2 × 10 <sup>12</sup> Ω
Input impedance, reference:	> 2 × 10 <sup>12</sup> Ω
Temperature compensation:	Built-in sensor, - 20 ... + 80 °C
Output:	4 - 20 mA for pH / mV / temperature
Accuracy:	± 0,01 pH / 1 mV
Linearity:	± 0,01 pH / 1 mV
Repeatability:	± 1 %
Response time:	Approx. 10 sec.
CE approvals:	EN61000-6-1:2002, EN61000-6-3:2002
Communication:	HART <sup>®</sup> protocol

Dimensions

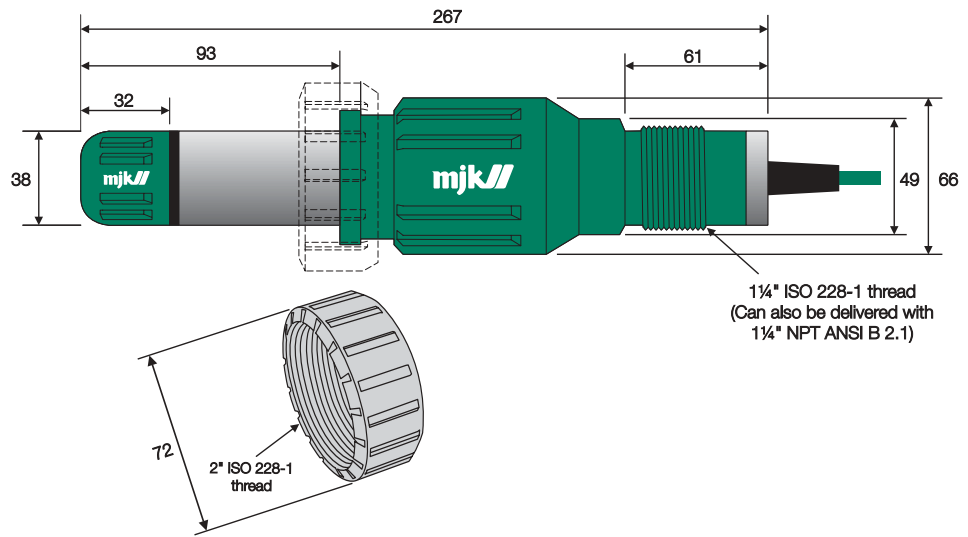

Electrical connection

*pHix<sup>®</sup> Compact* has either 1 or 2 x 4-20 mA signal outputs, and the cable will therefore have either 3 or 5 wires respectively:

Nr.:	Designation:	Colour:	Channel:
1	Shield	(none)	
2	+ 12-30 V DC	Red	pH or redox signal
3	- 4-20 mA	Black	(output 1)
4	+ 12-30 V DC	Yellow	Temperature signal
5	- 4-20 mA	Orange	(output 2)

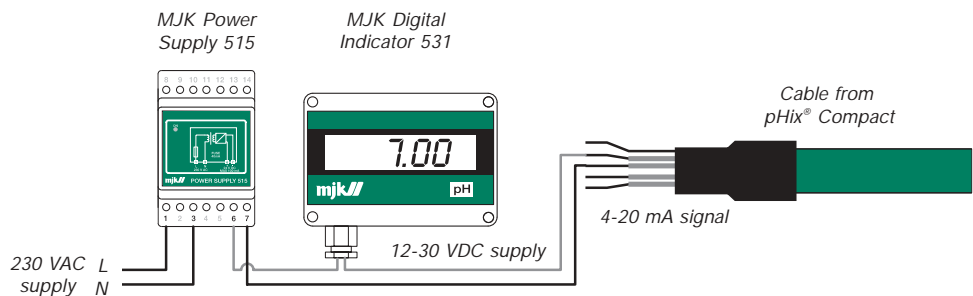

## Order numbers

*pHix® Compact*

203105	pHix® Compact pH transmitter without electrode
203107	pHix® Compact pH and temperature transmitter without electrode
203110	pHix® Compact pH transmitter complete with electrode (no. 160310)
203112	pHix® Compact pH and temperature transmitter complete with electrode (no. 160310)
203120	pHix® Compact redox transmitter complete with electrode (no. 160312)

*Electrodes*

160310	pHix® Compact pH electrode, pH 1 - 14; 0 - 80 °C, 0=4,6 pH
160311	pHix® Compact pH electrode, pH 1 - 14; 0 - 80 °C, 0=7 pH
160312	pHix® Compact redox electrode, 0 - 80 °C

*Mounting equipment*

155205	Fitting for submersion, made from acid-proof steel
200205	Universal bracket
200210	Wall bracket for extension
200215	Extension for universal bracket
521409	Union ring for mounting on connection piece

*Electrolyte, cleaning liquid and buffer liquids*

163010	KCl (0,5 l)
163020	Pepsin solution (0,25 l)
163030	pH buffer kit, pH 4, pH 7 and pH 10 (6 x 25 ml)
163032	pH buffer, pH 4,00 (1 l)
163034	pH buffer, pH 7,00 (1 l)
163036	pH buffer, pH 10,00 (1 l)
163040	Redox buffer kit, value 285 mV (6 x 25 ml)

## Accessories

